

CSP-dot Series Specification

PD70RGBW

24V-10mm



【General description】

- RGBW colorful strip
- The EFW process has a unique structure, using special profiles, does not require adhesive backing, and is easy to install
- Side-exit cable plug, seamless lighting with no dark spots
- Operating Temperature, Ta: -40-60°C; Tc: 75°C (max)
- 5 years warranty

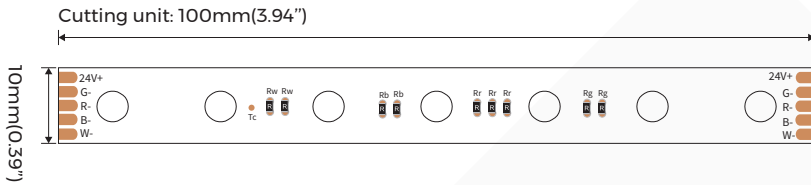
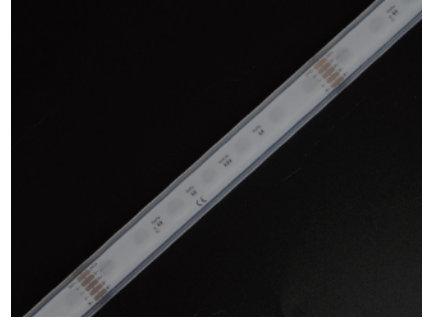

【Dimension】

- | | |
|----------------------------------|--|
| Input voltage: DC24V | Max.length: 5000mm(16.4') |
| CRI: 90(W) | Cutting unit: 100mm(3.93") |
| Max.power: 15.4W(1m) | LED pitch: 14.28mm(0.56") |
| Power range: 12.6~15.4W(1m) | Min. bend diameter: Φ 60mm(2.36") |
| Rated current: 0.58A(1m) | Mounting: 3M tape |
| Typical Power: 14W(1m) | Copper foil: 3oz |
| IP: IP20/IP67 | |
| On-off times: 10000 (test times) | |
| Warranty: 5years | |

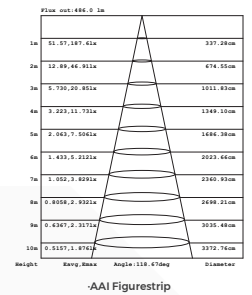
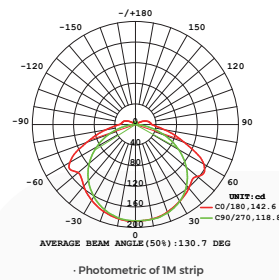

【Photo-electric Parameters】



| CRI | Color | CCT | Lumen(lm/m) | Lumen(lm/ft) | lm/W | ErP 2019 |
|-----|-------|-----------|-------------|--------------|------|----------|
| / | RGBSW | RGB+2700K | 825 | 253 | 59 | / |
| / | RGBWW | RGB+3000K | 855 | 260 | 61 | / |
| / | RGBNW | RGB+4000K | 895 | 273 | 64 | / |
| / | RGBW | RGB+6500K | 855 | 260 | 61 | / |

- 1.The tolerance of output data can be vary up to 15%.
- 2.the output data tested according to IES TM-30-15.
- 3.the output data is based on IP20/Imertex, data of 5m in only for reference.
- 4.IP protection process leads changes to size, CCT and luminous flux.

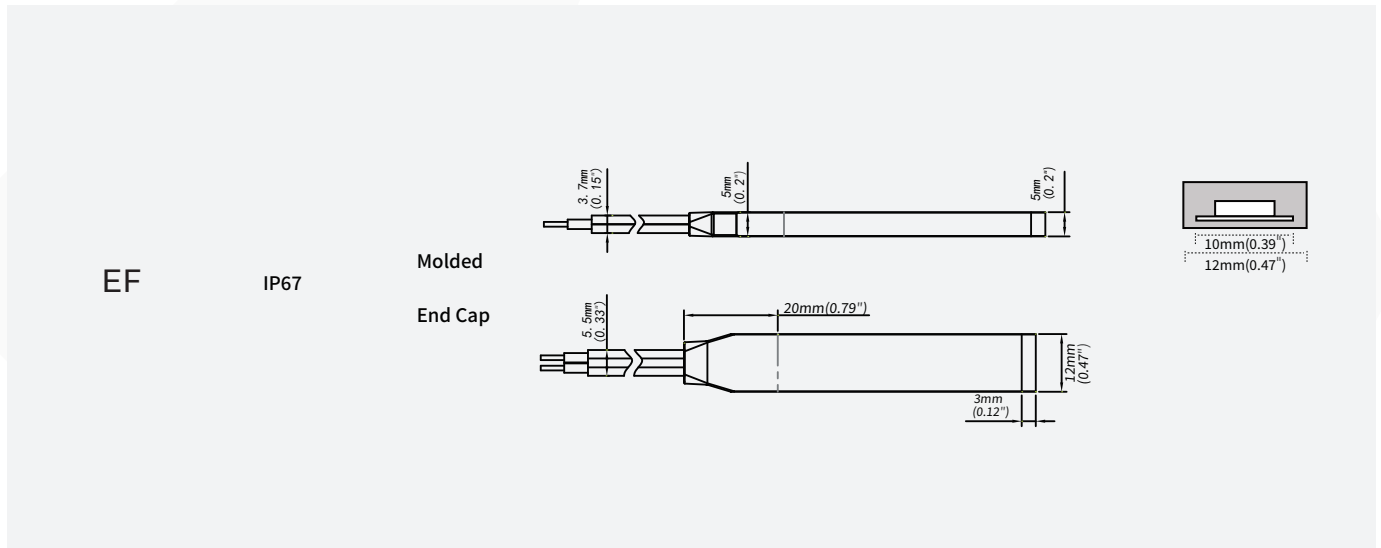
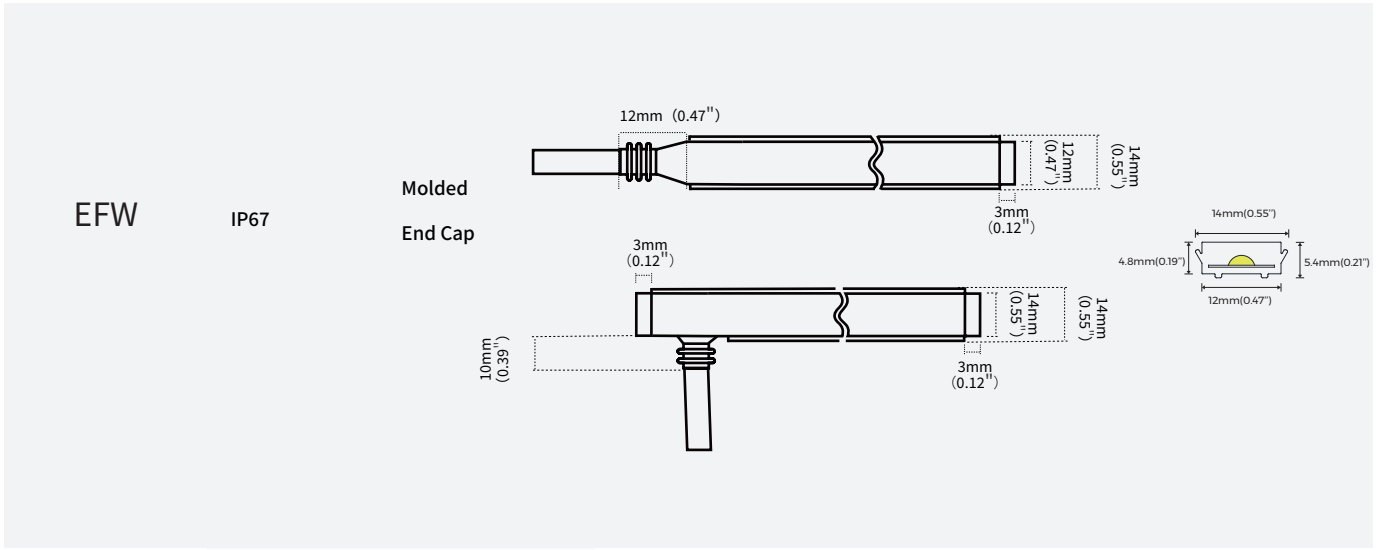











【IP process information】



【Electronic & output data】

| IP Process | Picture | Picture description | Size | optional CCT/color for finished product | lumen output rate |
|------------|---|---------------------|------------|---|-------------------|
| NO |  | No proof | 10mm*1.7mm | RGB+2700K/3000K/4000K/6500K | 100% |
| EFW |  | No proof | 14mm*5.4mm | RGB+2700K/3000K/4000K/6500K | 86% |
| EF |  | No proof | 12mm*5mm | RGB+2700K/3000K/4000K/6500K | 86% |

[Product Solutions]

| Name | Picture | Code | coding | description |
|--------------------------|---|----------------|---|---|
| Alumina carrier |  | / | CLS10EFW-12050100 | size:L1000*W15.4*H7.4mm |
| Aluminum clip |  | / | FLS10EFW-1205 | size:L25*W15.4*H7.4mm |
| 5P male connector wire |  | / | AS-FC-0021(0.25M) AS-FC-0022(0.5M) AS-FC-0023(2M) | suitable for RGBW/DMX led strip Wire lengths are optional: 0.25M/0.5M/2 |
| 5P female connector wire |  | / | AS-FC-0024(0.25M) AS-FC-0025(0.5M) AS-FC-0026(2M) | suitable for RGBW/DMX led strip Wire lengths are optional: 0.25M/0.5M/2 |
| 5P T-Connection Wire |  | / | AS-FC-0029 | suitable for RGBW/DMX led strip Wire length 150mm |
| Fixed Clip |  | 94-02-00-0003 | FSW10SA | Silicone clip, screw: PA 3*8mm, suitable for 10mm FPC,EF/ET strip |
| Silicone Plug Kit |  | 94-02-00-0046 | DT10EA-A | Silicone plug kit is suitable for 10mm board width, ET/EF series silicone extrusion light strip |
| Silicone stopper kit |  | 94-02-00-0047 | DW10EA-A | Silicone tail plug kit is suitable for 10mm board width, ET/EF series silicone extrusion light strip |
| Mounting groove |  | 94-02-00-0025 | CVT10EA-14100100 | Transparent PVC mounting groove,suitable for 10mm FPC,silicone extruded EF/ET strip |
| Stopper glue |  | 94-16-03010001 | AS-PG-0003 | Silicone gel,suitable for ET/EF/EG waterproof LED strip |
| RGB/RGBW remote control |  | / | R8-1 | output signal: RF Working voltage: 3VDC(CR2032) Remote control distance: 30m Working temperature:Ta:0-30 C~0+55 C |
| RGBW controller |  | / | CR4-GBA | Input voltage: DC12-48V Output current: 20A Output Power: Max 240W@12V/Max 480W @24V/Max 720W@36V/Max 960W@48V Working temperature: -30 C— +55 C |

[Packing]

Colors brand package(NONA)

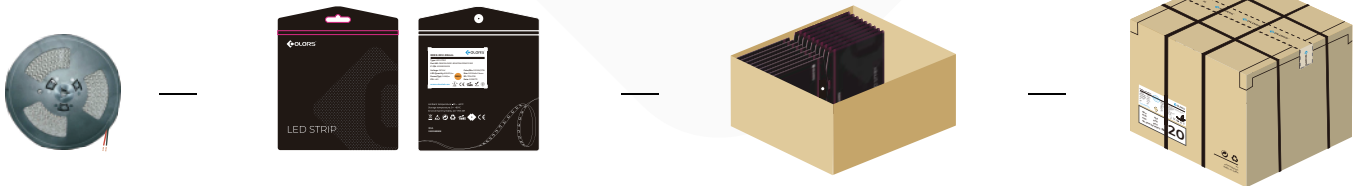

General customized package(EF/EFW)

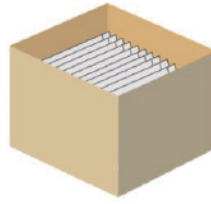

| IP Process | Product size(mm) | Product quantity (m/reel) | Product quantity (m/case) | Product net weight(kg) | Net weight per box(kg) | Gross weight(kg) | Package size (cm) |
|------------|------------------|---------------------------|---------------------------|------------------------|------------------------|------------------|-------------------|
| NO | 5000*10*1.7 | 5 | 300 | 0.125 | 12.55 | 13.55 | 41*41*26 |
| EFW | 5000*14*5.4 | 5 | 125 | 0.5 | 12.5 | 13.8 | 29*29*56 |
| EF | 5000*12*5 | 5 | 200 | 0.45 | 18 | 19.8 | 41*41*26 |

Remark: data with 10% tolerance

[Precautions]

- Please drive the led strip with 24VDC isolated power, and the ripple of the constant voltage source should be less than 5%.
- Please do not bend the strip into an arc with a diameter less than 60mm to ensure the longevity and reliability.
- Do not fold it in case any damage of LED beads.
- Do not pull the power wire hard to ensure the longevity. Any Crash may damage the LED light is prohibited.
- Please make sure the wire is connected to the anode and cathode correctly. The power output should be consistent with the voltage of the strip to avoid damage.
- LED lights should be stored in dry, sealed environment. Please only unpack it before usage. Ambient temperature: -25℃~40℃. Storage temperature: 0℃~60℃. Please use the strips without waterproof within indoor environment with humidity less than 70%.
- Please be careful during operation. Do not touch the AC power supply in case of electric shock.
- Please leave at least 20% power for the power supply during using to ensure there is enough power supply to drive the product.
- Do not use any acid or alkaline adhesives to fix the product (e.g.: glass cement).
- Do not scratch the product when IP process of the product is NA. Ultraviolet rays will damage the nano-layers on the product and seriously affect the life of the product.